

PR
electronics



6 3 3 5

**2-Wire HART[®]
Transmitter**

No. 6335V110-UK
From ser. no. 100924000



- DK ▶** PR electronics A/S tilbyder et bredt program af analoge og digitale signalbehandlingsmoduler til industriel automation. Programmet består af Isolatorer, Displays, Ex-barrierer, Temperaturtransmittere, Universaltransmittere mfl. Vi har modulerne, du kan stole på i selv barske miljøer med elektrisk støj, vibrationer og temperaturudsving, og alle produkter opfylder de strengeste internationale standarder. Vores motto »Signals the Best« er indbegrebet af denne filosofi - og din garanti for kvalitet.
- UK ▶** PR electronics A/S offers a wide range of analog and digital signal conditioning devices for industrial automation. The product range includes Isolators, Displays, Ex Interfaces, Temperature Transmitters, and Universal Modules. You can trust our products in the most extreme environments with electrical noise, vibrations and temperature fluctuations, and all products comply with the most exacting international standards. »Signals the Best« is the epitome of our philosophy - and your guarantee for quality.
- FR ▶** PR electronics A/S offre une large gamme de produits pour le traitement des signaux analogiques et numériques dans tous les domaines industriels. La gamme de produits s'étend des transmetteurs de température aux afficheurs, des isolateurs aux interfaces SI, jusqu'aux modules universels. Vous pouvez compter sur nos produits même dans les conditions d'utilisation sévères, p.ex. bruit électrique, vibrations et fluctuations de température. Tous nos produits sont conformes aux normes internationales les plus strictes. Notre devise »SIGNALS the BEST« c'est notre ligne de conduite - et pour vous l'assurance de la meilleure qualité.
- DE ▶** PR electronics A/S verfügt über ein breites Produktprogramm an analogen und digitalen Signalverarbeitungsgeräte für die industrielle Automatisierung. Dieses Programm umfasst Displays, Temperaturtransmitter, Ex- und galvanische Signaltrenner, und Universalgeräte. Sie können unsere Geräte auch unter extremen Einsatzbedingungen wie elektrisches Rauschen, Erschütterungen und Temperaturschwingungen vertrauen, und alle Produkte von PR electronics werden in Übereinstimmung mit den strengsten internationalen Normen produziert. »Signals the Best« ist Ihre Garantie für Qualität!

2-WIRE HART® TRANSMITTER

PRETRANS 6335

CONTENTS

| | |
|---|----|
| Application..... | 2 |
| Technical characteristics..... | 2 |
| Mounting / installation | 2 |
| Applications..... | 3 |
| Order: 6335..... | 4 |
| Electrical specifications..... | 4 |
| Connections | 8 |
| Block diagram..... | 10 |
| Programming | 11 |
| Connection of transmitters in multidrop mode..... | 13 |
| Appendix | 14 |
| ATEX Installation Drawing - 6335A | 15 |
| IECEX Installation Drawing - 6335A..... | 17 |
| ATEX Installation Drawing - 6335D..... | 19 |
| IECEX Installation Drawing - 6335D..... | 21 |
| FM Installation Drawing - 6335D..... | 23 |
| CSA Installation Drawing - 6335D | 24 |

2-WIRE HART® TRANSMITTER PRETRANS 6335

- *RTD, TC, Ohm, or mV input*
- *Extremely high measurement accuracy*
- *HART® communication*
- *Galvanic isolation*
- *1- or 2-channel version*

Application

- Linearised temperature measurement with Pt100...Pt1000, Ni100...Ni1000, TC or sensor.
- Difference or average temperature measurement of 2 resistance or TC sensors.
- Conversion of linear resistance variation to a standard analogue current signal, for instance from valves or Ohmic level sensors.
- Amplification of a bipolar mV signal to a standard 4...20 mA current signal.
- Connection of up to 15 channels to a digital 2-wire signal with HART® communication.

Technical characteristics

- Within a few seconds the user can program PR6335 to measure temperatures within all ranges defined by the norms.
- The RTD and resistance inputs have cable compensation for 2-, 3- and 4-wire connection.
- The 6335 has been designed according to strict safety requirements and is thus suitable for application in SIL 2 installations.
- A limit can be programmed on the output signal.
- Continuous check of vital stored data for safety reasons.
- Sensor error detection according to the guidelines in NAMUR NE 89.

Mounting / installation

- Mounted vertically or horizontally on a DIN rail. As the modules can be mounted without any distance between neighbouring units, up to 84 channels can be mounted per metre.
- **NB:** As Ex barrier for 6335D we recommend 5106B.

APPLICATIONS

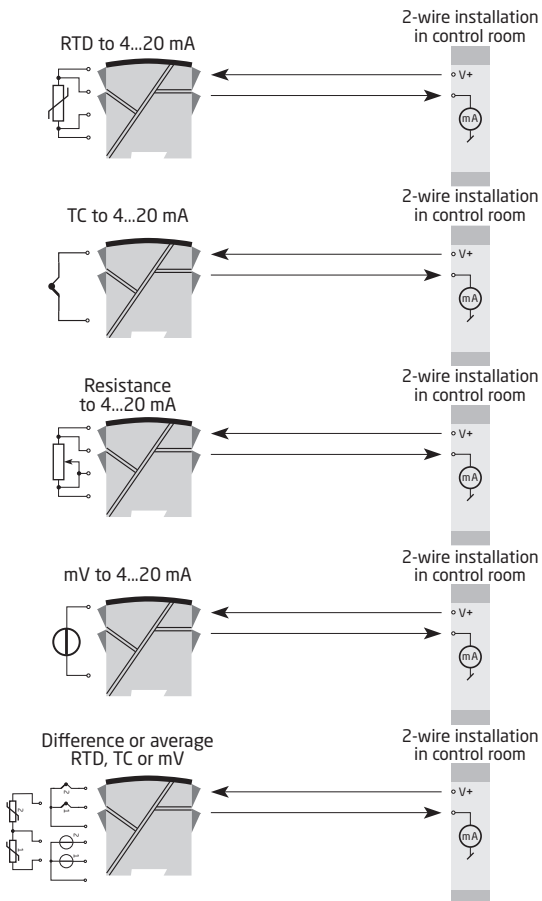

Order: 6335



| Type | Version | Galvanic isolation | Channels |
|------|--|--------------------|--------------------------|
| 6335 | Standard : A CSA, FM, : D ATEX & IECEx | 1500 VAC : 2 | Single : A Double : B |

***NB!** Please remember to order CJC connectors type 5910/5910Ex (channel 1) and 5913/5913Ex (channel 2) for TC inputs with an internal CJC.

Electrical specifications

Specifications range:

-40°C to +60°C

Common specifications:

Supply voltage, DC

Standard..... 8.0...35 VDC

CSA, FM, ATEX & IECEx 8.0...30 VDC

Isolation voltage, test / operation..... 1.5 kVAC / 50 VAC

Isolation voltage, channel 1 / channel 2:

Standard..... 3.75 kVAC

CSA, FM, ATEX & IECEx 1500 VAC

Warm-up time..... 30 s

Communications interface Loop Link and HART®

Signal / noise ratio Min. 60 dB

Response time (programmable)..... 1...60 s

EEProm error check < 10 s

Signal dynamics, input..... 22 bit

Signal dynamics, output 16 bit

Calibration temperature 20...28°C

Accuracy, the greater of general and basic values:

| General values | | |
|----------------|-------------------|-------------------------|
| Input type | Absolute accuracy | Temperature coefficient |
| All | ≤ ±0.05% of span | ≤ ±0.005% of span / °C |

| Basic values | | |
|---------------------------------|--------------------------------|---|
| Input type | Basic accuracy | Temperature coefficient |
| Pt100 and Pt1000 | $\leq \pm 0.1^{\circ}\text{C}$ | $\leq \pm 0.005^{\circ}\text{C}/^{\circ}\text{C}$ |
| Ni100 | $\leq \pm 0.2^{\circ}\text{C}$ | $\leq \pm 0.005^{\circ}\text{C}/^{\circ}\text{C}$ |
| Lin. R | $\leq \pm 0.1 \Omega$ | $\leq \pm 5 \text{ m}\Omega / ^{\circ}\text{C}$ |
| Volt | $\leq \pm 10 \mu\text{V}$ | $\leq \pm 0.5 \mu\text{V} / ^{\circ}\text{C}$ |
| TC type: E, J, K, L, N, T, U | $\leq \pm 0.5^{\circ}\text{C}$ | $\leq \pm 0.025^{\circ}\text{C} / ^{\circ}\text{C}$ |
| TC type: B, R, S, W3, W5 | $\leq \pm 1^{\circ}\text{C}$ | $\leq \pm 0.1^{\circ}\text{C} / ^{\circ}\text{C}$ |

| | |
|---|-----------------------|
| EMC immunity influence | $< \pm 0.1\%$ of span |
| Extended EMC immunity: NAMUR NE 21, A criterion, burst | $< \pm 1\%$ of span |

| | |
|--|---------------------------------------|
| Effect of supply voltage variation | $< 0.005\%$ of span / VDC |
| Max. wire size | 1 x 1.5 mm ² stranded wire |
| Humidity | $< 95\%$ RH (non-cond.) |
| Dimensions | 109 x 23.5 x 104 mm |
| Protection degree | IP20 |
| Weigh (1 / 2 channels) | 145 / 185 g |

Electrical specifications, inputs:

| | |
|-------------------|--------------------------------------|
| Max. offset | 50% of selected numerical max. value |
|-------------------|--------------------------------------|

RTD and linear resistance input:

| RTD type | Min. value | Max. value | Min. span | Standard |
|----------|------------|------------|-----------|-----------|
| Pt100 | -200°C | +850°C | 10°C | IEC 60751 |
| Ni100 | -60°C | +250°C | 10°C | DIN 43760 |
| Lin. R | 0 Ω | 7000 Ω | 25 Ω | ----- |

| | |
|---|---------------------------|
| Cable resistance per wire (max.) | 5 Ω |
| (up to 50 Ω per wire is possible with reduced measurement accuracy) | |
| Sensor current | Nom. 0.2 mA |
| Effect of sensor cable resistance (3- / 4-wire) | $< 0.002 \Omega / \Omega$ |
| Sensor error detection | Yes |
| Short circuit detection | If 0% $> 30 \Omega$ |

TC inputs:

| Type | Min. temperature | Max. temperature | Min. span | Standard |
|------|------------------|------------------|-----------|--------------|
| B | +400°C | +1820°C | 100°C | IEC584 |
| E | -100°C | +1000°C | 50°C | IEC584 |
| J | -100°C | +1200°C | 50°C | IEC584 |
| K | -180°C | +1372°C | 50°C | IEC584 |
| L | -100°C | +900°C | 50°C | DIN 43710 |
| N | -180°C | +1300°C | 50°C | IEC584 |
| R | -50°C | +1760°C | 100°C | IEC584 |
| S | -50°C | +1760°C | 100°C | IEC584 |
| T | -200°C | +400°C | 50°C | IEC584 |
| U | -200°C | +600°C | 50°C | DIN 43710 |
| W3 | 0°C | +2300°C | 100°C | ASTM E988-90 |
| W5 | 0°C | +2300°C | 100°C | ASTM E988-90 |

| | |
|--|---------------------------------|
| Cold junction compensation | < ±1.0°C |
| External CJC with Ni100 or Pt100 | -40 ≤ T _{amb.} ≤ 135°C |
| Sensor error detection..... | Yes |
| Sensor error current: | |
| When detecting..... | Nom. 33 µA |
| Else..... | 0 µA |
| Short circuit detection..... | No |

Voltage inputs:

| | |
|-------------------------|----------------|
| Measurement range | -800...+800 mV |
| Min. span | 2.5 mV |
| Input resistance..... | 10 MΩ |

Current output:

| | |
|------------------------------------|---|
| Signal range | 4...20 mA |
| Min. signal range..... | 16 mA |
| Updating time | 440 ms (660 ms for diff.) |
| Fixed output signal..... | Between 4 and 20 mA |
| Output signal at EEPROM error..... | ≤ 3.5 mA |
| Load resistance..... | ≤ (V _{supply} - 8) / 0.023 [Ω] |
| Load stability..... | < ±0.01% of span / 100 Ω |

Sensor error detection:

| | |
|--|-------------|
| Programmable | 3.5...23 mA |
| (shorted sensor error detection is ignored at TC and mV input) | |
| NAMUR NE43 Upscale..... | 23 mA |
| NAMUR NE43 Downscale..... | 3.5 mA |
| Of span = Of the presently selected range | |

Approvals:

EMC 2004/108/EC EN 61326-1

GOST R

Ex / I.S.:

6335A:

ATEX 94/9/EC KEMA 10ATEX0006 X

IECEX..... KEM 10.0084 X

6335D:

ATEX 94/9/EC KEMA 09ATEX0148

IECEX..... KEM 10.0084 X

FM certificate..... 2D5A7

CSA certificate..... 1125003

GOST Ex

Functional Safety:

Hardware assessed for use in SIL applications

FMEDA report - www.prelectronics.com

CONNECTIONS

Inputs:

Channel 1

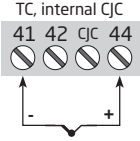
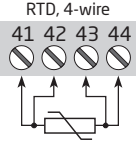
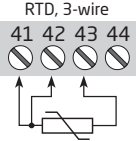
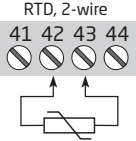

Channel 2

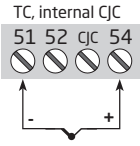
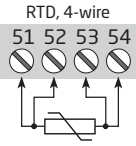
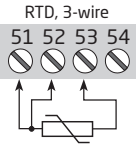
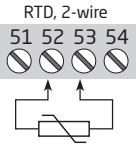

Channel 1

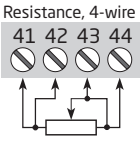
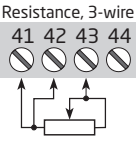
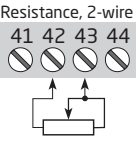
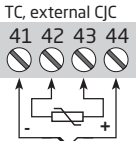

Channel 2

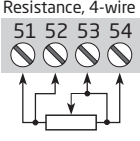
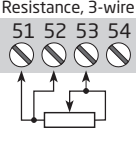
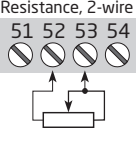
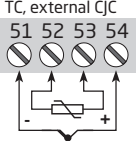

CONNECTIONS

Inputs:

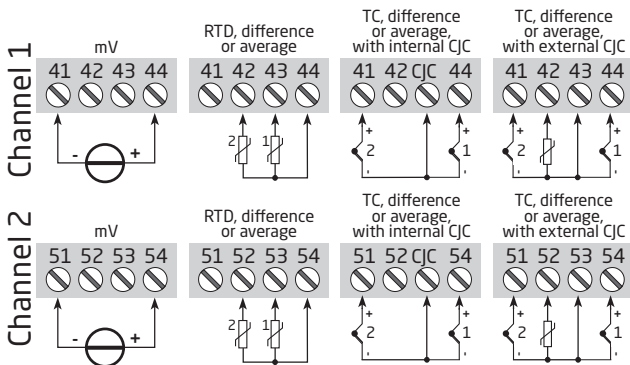

Outputs:

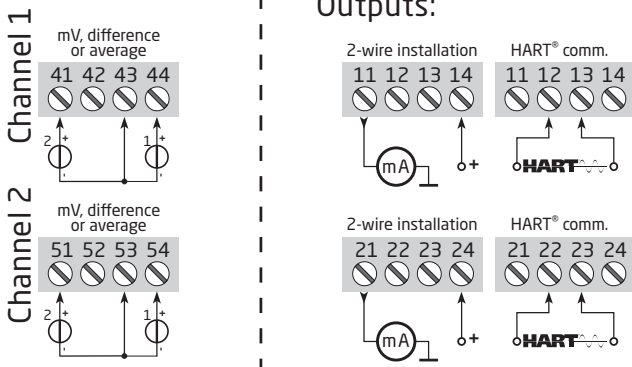

BLOCK DIAGRAM

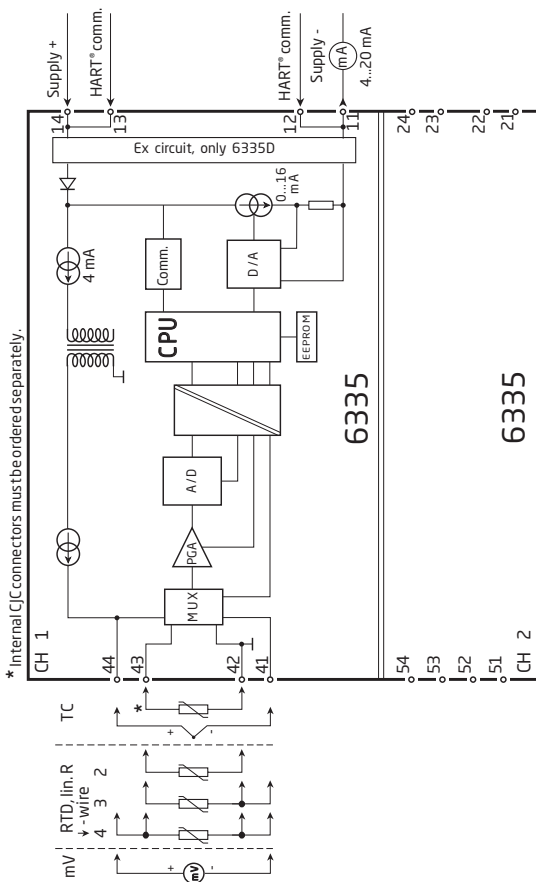

PROGRAMMING

PRetrans 6335 can be configured in the following 3 ways:

1. With PR electronics A/S' communications interface Loop Link and PRreset PC configuration software.
2. With a HART® modem and PRreset PC configuration software.
3. With a HART® communicator with PR electronics A/S' DDL driver.

1: Loop Link

For programming please refer to the drawing below and the help functions in PRreset.

When communicating with non-installed modules, connectors 11, 12, 13, 14 (channel 1) and 21, 22, 23, 24 (channel 2) can be dismantled in the safe area to connect the terminals of the communications interface to the pins.

Loop Link is not approved for communication with modules installed in hazardous (Ex) area.

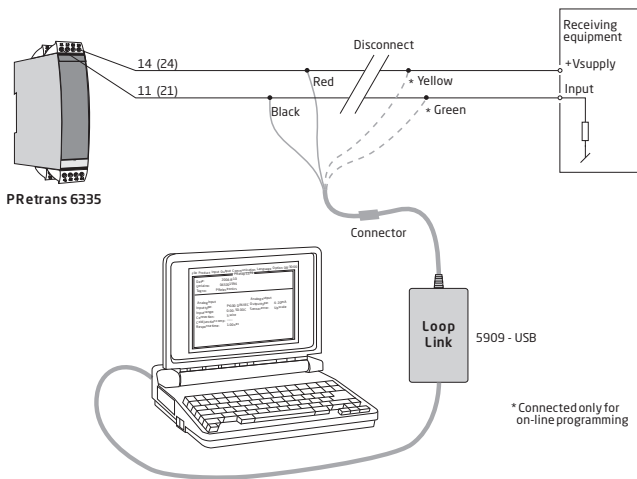

2: HART® modem

For programming please refer to the drawing below and the help functions in PReset.

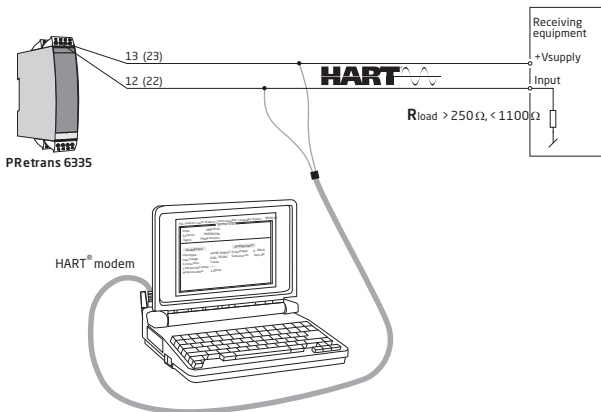

3: HART® communicator

For programming please refer to the drawing below. To get access to product-specific commands, the HART® communicator must be loaded with the PR electronics A/S DDL driver. This can be ordered either at the HART® Communication Foundation or PR electronics A/S.

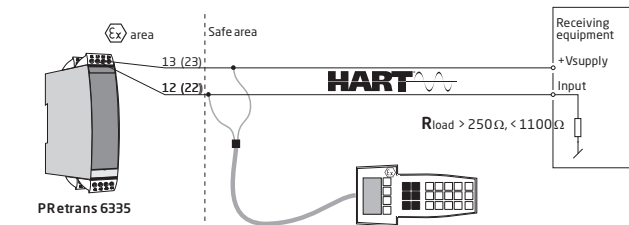

CONNECTION OF TRANSMITTERS IN MULTIDROP MODE

- The HART[®] communicator or a PC modem can be connected across AB or BC.

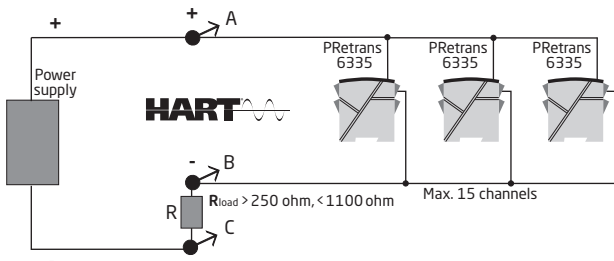

- The outputs of max. 15 transmitters can be connected in parallel for a digital HART[®] communication on 2-wires.
- Before it is connected, each transmitter must be configured with a unique number from 1 to 15. If 2 transmitters are configured with the same number, both will be excluded. The transmitters must be programmed for multidrop mode (with a fixed output signal of 4 mA). Maximum current in the loop is therefore 60 mA.
- The communication is either by means of a HART[®] communicator or a HART[®] modem.
- The PReset PC configuration software can configure the individual transmitter for multidrop mode and provide it with a unique polling address.

APPENDIX

ATEX INSTALLATION DRAWING - 6335A

IECEX INSTALLATION DRAWING - 6335A

ATEX INSTALLATION DRAWING - 6335D

IECEX INSTALLATION DRAWING - 6335D

FM INSTALLATION DRAWING NO. 6335QF01

CSA INSTALLATION DRAWING NO. 6335QC02

ATEX Installation drawing

For safe installation of 6335A, 6336A or 6337A the following must be observed. The module shall only be installed by qualified personnel who are familiar with the national and international laws, directives and standards that apply to this area.

Year of manufacture can be taken from the first two digits in the serial number.

ATEX Certificate KEMA 10ATEX 0006X

Marking



II 3 G Ex nA [ic] IIC T6...T4 Gc
 II 3 G Ex ic IIC T6...T4 Gc
 II 3 D Ex ic IIIC Dc

Standards

EN 60079-0 : 2009, EN 60079-11:2007,
 EN 60079-15: 2010, EN 61241-11:2006

T6: -40°C to 60 °C
 T4: -40°C to 85 °C

Hazardous Area Zone 2 or Zone 22

Terminal:
41,42,43,44 /
51,52,53,54

Ex nA [ic]

U_o: 9.6 VDC
 I_o: 28 mA
 P_o: 67 mW
 L_o: 35 mH
 C_o: 3.5 µF

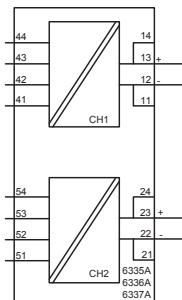

Terminal:
11,12,13,14
21,22,23,24

Ex nA

U ≤ 35 VDC
 I = 4 - 20 mA

Ex ic

U_i: 35 VDC
 L_i: 10 µH
 C_i: 2.0 nF

Special conditions for safe use.

Type of protection Ex ic IIC Gc:

The transmitter shall be installed in an enclosure that provides a degree of protection of at least IP54 according to EN60529.

Type of protection Ex ic IIIC Dc:

The transmitter shall be installed in an enclosure providing a degree of protection of at least IP6X according to EN60529. The surface temperature of the enclosure is equal to the ambient temperature +20 K, for a dust layer with a maximum thickness of 5 mm.

IECEX Installation drawing

For safe installation of 6335A, 6336A or 6337A the following must be observed. The module shall only be installed by qualified personnel who are familiar with the national and international laws, directives and standards that apply to this area.

Year of manufacture can be taken from the first two digits in the serial number.

| | |
|-------------------|---|
| IECEX Certificate | IECEX KEM.10.0084X |
| Marking | Ex nA [ic] IIC T6 Gc Ex ic IIC T6 Gc Ex ic IIIC Dc |
| Standards | IEC60079-11:2006, IEC60079-0: 2007, IEC60079-26:2006, IEC60079-15:2010, IEC61241-11:2005 |

T6: -40°C to 60 °C

Hazardous Area Zone 2 or Zone 22

Terminal:
41,42,43,44 /
51,52,53,54

Ex nA [ic]

U_o: 9.6 VDC
I_o: 28 mA
P_o: 67 mW
L_o: 35 mH
C_o: 3.5µF

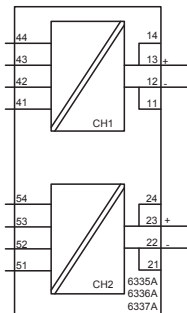

Terminal:
11,12,13,14
21,22,23,24

Ex nA

U ≤ 35 VDC
I = 4 - 20 mA

Ex ic

U_i : 35 VDC
L_i : 10 µH
C_i : 2.0 nF

Installation notes.

Type of protection Ex ic IIC Gc or Ex nA IIC Gc

The transmitter shall be installed in an enclosure that provides a degree of protection of at least IP54 according to IEC60529.

Type of protection Ex ia IIIC Da:

The transmitter shall be installed in an enclosure that provides a degree of protection of at least IP6X according to IEC60529. The surface temperature of the enclosure is equal to the ambient temperature +20 K, for a dust layer with a maximum thickness of 5 mm.

ATEX Installation drawing



For safe installation of 6335D, 6336D or 6337D the following must be observed. The module shall only be installed by qualified personnel who are familiar with the national and international laws, directives and standards that apply to this area.

Year of manufacture can be taken from the first two digits in the serial number.

ATEX Certificate KEMA 09ATEX 0148

Marking



II 1 G Ex ia IIC T6..T5 Ga
II 1D Ex ia IIC Da

Standards

EN60079-0:2009, EN60079-11:2007, EN60079-26:2007, EN61241-11:2006

Hazardous area

Zone 0, 1, 2, 20, 21, 22

T5: $-40 \leq T_a \leq 60^\circ\text{C}$

T6: $-40 \leq T_a \leq 40^\circ\text{C}$

Terminal:

41,42,43,44

Uo: 9.6 VDC

Io: 28 mA

Po: 67 mW

Lo: 35 mH

Co: 3.5µF

Terminal:

51,52,53,54

Uo: 9.6 VDC

Io: 28 mA

Po: 67 mW

Lo: 35 mH

Co: 3.5µF

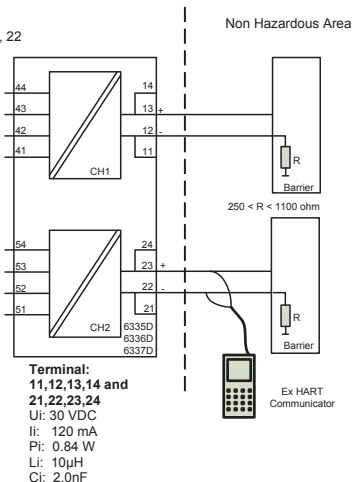

Installation notes

The sensor circuit is not infallibly galvanic isolated from the supply output circuit. However, the galvanic isolation between the circuits is capable of withstanding a test voltage of 500Vac during 1 minute.

Type of protection Ex ia IIC Ga:

The transmitter shall be installed in an enclosure that provides a degree of protection of at least IP20 according to EN60529.

Type of protection Ex ia IIIC Da:

The transmitter shall be installed in an enclosure that provides a degree of protection of at least IP6X according to EN60529. The surface temperature of the enclosure is equal to the ambient temperature +20 K, for a dust layer with a maximum thickness of 5 mm.

IECEX Installation drawing



For safe installation of 6335D, 6336D or 6337D the following must be observed. The module shall only be installed by qualified personnel who are familiar with the national and international laws, directives and standards that apply to this area.

Year of manufacture can be taken from the first two digits in the serial number.

| | |
|-------------------|---|
| IECEX Certificate | IECEX KEM.10.0084X |
| Marking | Ex ia IIC T6..T5 Ga Ex ia IIIC Da |
| Standards: | IEC60079-11:2006, IEC60079-0: 2007, IEC60079-26:2006, IEC61241-11:2005 |

Hazardous area
Zone 0, 1, 2, 20, 21, 22

T5: $-40 \leq T_a \leq 60^\circ\text{C}$
T6: $-40 \leq T_a \leq 40^\circ\text{C}$

Non Hazardous Area

Terminal:

41,42,43,44
Uo: 9.6 VDC
Io: 28 mA
Po: 67 mW
Lo: 35 mH
Co: 3.5 μ F

Terminal:

51,52,53,54
Uo: 9.6 VDC
Io: 28 mA
Po: 67 mW
Lo: 35 mH
Co: 3.5 μ F

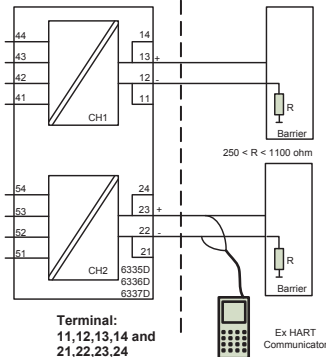

Terminal:
11,12,13,14 and
21,22,23,24
Ui: 30 VDC
Ii: 120 mA
Pi: 0.84 W
Li: 10 μ H
Ci: 2.0nF

Installation notes

The sensor circuit is not infallibly galvanic isolated from the supply output circuit. However, the galvanic isolation between the circuits is capable of withstanding a test voltage of 500Vac during 1 minute.

For installation in dust the following instructions apply:

The transmitter shall be mounted in a metal enclosure that is providing a degree of protection of at least IP6X according to IEC 60529. The surface temperature of the enclosure is equal to the ambient temperature +20 K, for a dust layer with a maximum thickness of 5 mm.

Cable entries and blanking elements shall be used that are suitable for the application and correctly installed

FM Installation drawing

Hazardous (Classified) Location
 Class I, Division 1, Group A,B,C,D
 Class I, Zone 0, IIC

T6: $-40 \leq T_a \leq 60^\circ\text{C}$

Non Hazardous Location

**Terminal:
 41,42,43,44**
 U_o: 9.6 VDC
 I_o: 28 mA
 P_o: 67 mW
 L_o: 35 mH
 C_o: 3.5µF

**Terminal:
 51,52,53,54**
 U_o: 9.6 VDC
 I_o: 28 mA
 P_o: 67 mW
 L_o: 35 mH
 C_o: 3.5µF

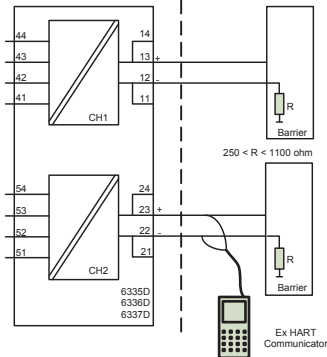

**Terminal:
 11,12,13,14 and
 21,22,23,24**
 U_i: 30 VDC
 I_i: 120 mA
 P_i: 0.84 W
 L_i: 10µH
 C_i: 2.0nF

Installation notes.

For installation in Class I the Transmitter must be installed in a suitable enclosure to meet installation codes stipulated in The National Electrical Code (ANSI-NFPA 70).

Equipment that is FM-approved for intrinsic safety may be connected to barriers based on the Entity Concept. This concept permits interconnection of approved transmitters, meters and other devices in combinations, which have not been specifically examined by FM, provided that the agency's criteria are met. The combination is then intrinsically safe, if the entity concept is acceptable to the authority having jurisdiction over the installation.

The entity concept criteria are as follows: The intrinsically safe devices, other than barriers, must not be a source of power. The maximum voltage $U_i(V_{MAX})$ and current $I_i(I_{MAX})$, and maximum power $P_i(P_{MAX})$, which the device can receive and remain intrinsically safe, must be equal to or greater than the voltage (U_o or V_{OC} or V_i) and current (I_o or I_{SC} or I_i) and the power P_o which can be delivered by the barrier. The sum of the maximum unprotected capacitance (C_i) for each intrinsically device and the interconnecting wiring must be less than the capacitance (C_a) which can be safely connected to the barrier. The sum of the maximum unprotected inductance (L_i) for each intrinsically device and the interconnecting wiring must be less than the inductance (L_a) which can be safely connected to the barrier. The entity parameters U_o , V_{OC} or V_i and I_o , I_{SC} or I_i , and C_a and L_a for barriers are provided by the barrier manufacturer.

CSA Installation drawing

Hazardous (Classified) Location
 Class I, Division 1, Group A,B,C,D
 Class I, Zone 0, IIC

T6: $-40 \leq T_a \leq 60^\circ\text{C}$

Non Hazardous Location

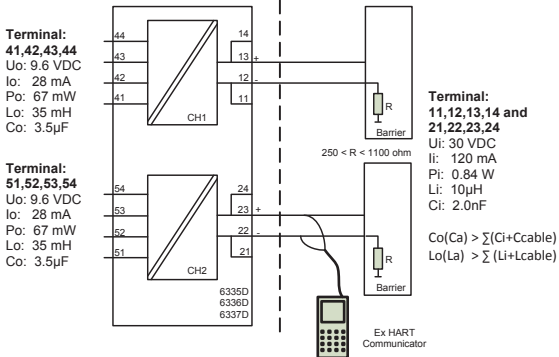

Installation notes.

The Transmitter must be installed in a suitable enclosure to meet installation codes stipulated in The Canadian Electrical Code (CEC).

Channel 1 and Channel 2 are separate channels and therefore separate shielded cables shall be used for each channel.

Substitution of components may impair intrinsic safety.



Displays Programmable displays with a wide selection of inputs and outputs for display of temperature, volume and weight, etc. Feature linearization, scaling, and difference measurement functions for programming via PReset software.



Ex interfaces Interfaces for analog and digital signals as well as HART® signals between sensors / I/P converters / frequency signals and control systems in Ex zone 0, 1 & 2 and for some devices in zone 20, 21 & 22.



Isolation Galvanic isolators for analog and digital signals as well as HART® signals. A wide product range with both loop-powered and universal isolators featuring linearization, inversion, and scaling of output signals.



























Temperature A wide selection of transmitters for DIN form B mounting and DIN rail devices with analog and digital bus communication ranging from application-specific to universal transmitters.



Universal PC or front programmable devices with universal options for input, output and supply. This range offers a number of advanced features such as process calibration, linearization and auto-diagnosis.



- 
 www.preelectronics.fr
 sales-fr@preelectronics.com
- 
 www.preelectronics.de
 sales-de@preelectronics.com
- 
 www.preelectronics.es
 sales-es@preelectronics.com
- 
 www.preelectronics.it
 sales-it@preelectronics.com
- 
 www.preelectronics.se
 sales-se@preelectronics.com
- 
 www.preelectronics.co.uk
 sales-uk@preelectronics.com
- 
 www.preelectronics.com
 sales-us@preelectronics.com
- 
 www.preelectronics.cn
 sales-cn@preelectronics.com

Head office

Denmark
 PR electronics A/S
 Lerbakken 10
 DK-8410 Rønde

www.preelectronics.com
sales-dk@preelectronics.com
 tel. +45 86 37 26 77
 fax +45 86 37 30 85



QUALITY SYSTEM AND ENVIRONMENTAL MANAGEMENT SYSTEM
 DS/EN ISO 9001
 DS/EN ISO 14001

